

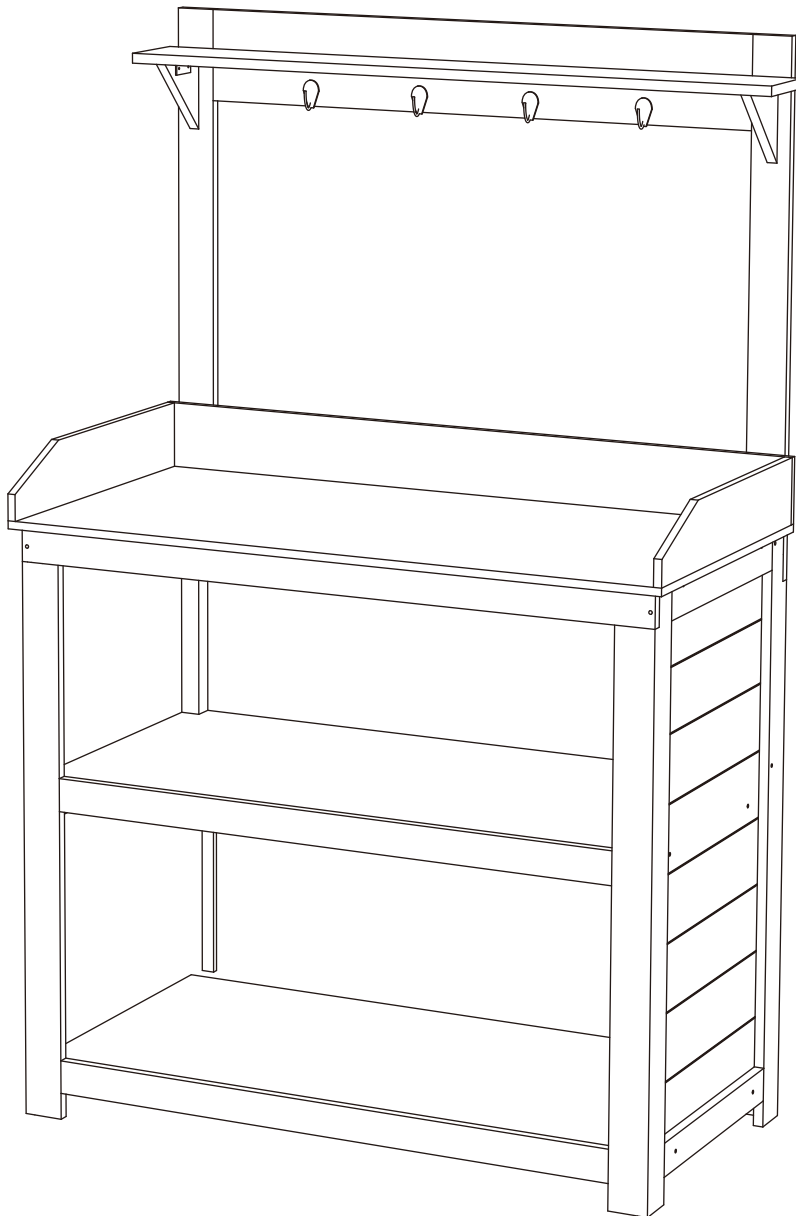

INbme019\_GL

845-688



IMPORTANT, RETAIN FOR FUTURE REFERENCE: READ CAREFULLY

# ASSEMBLY & INSTRUCTION MANUAL

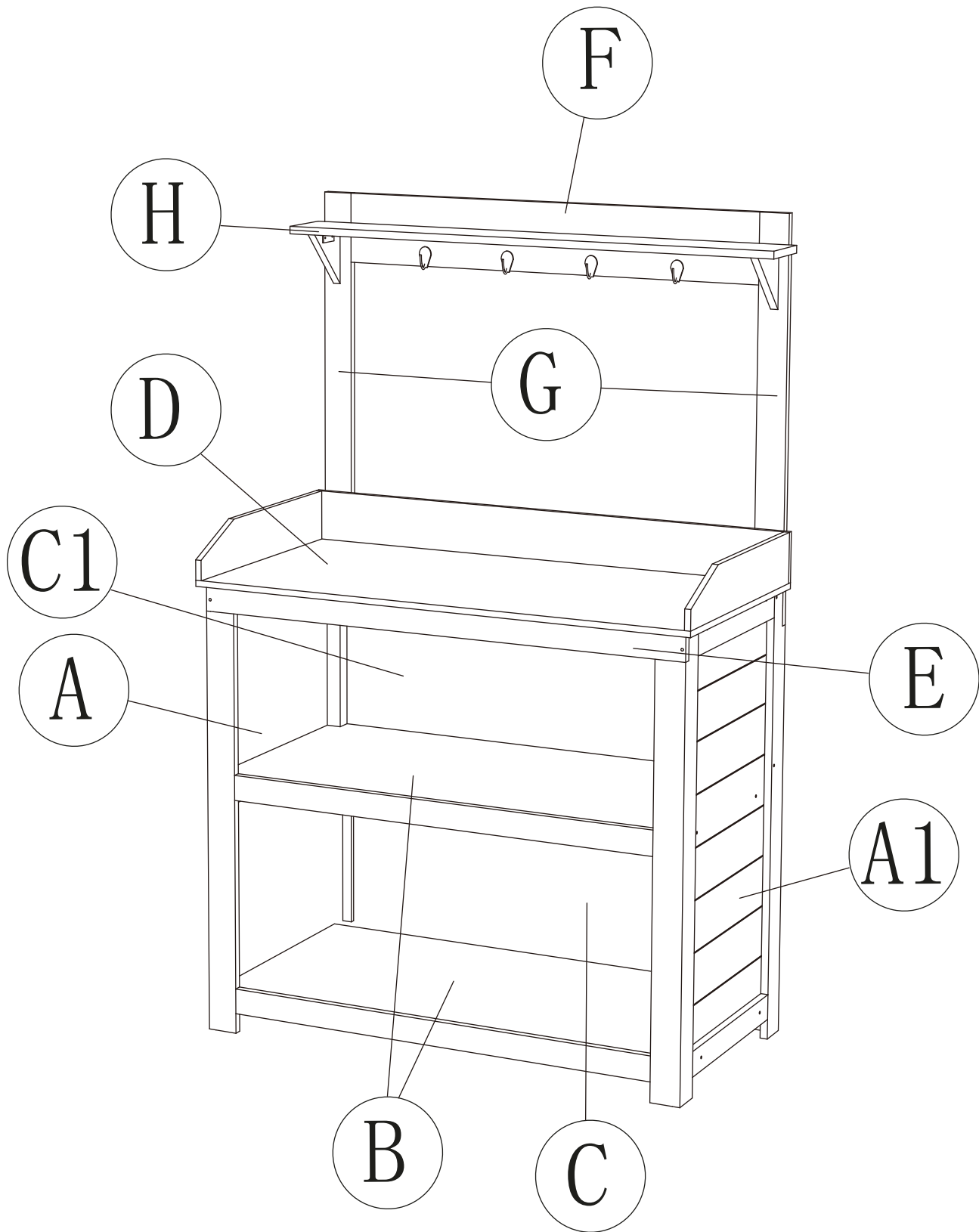

**PARTS**

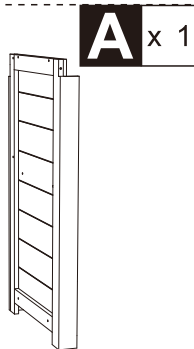

**A** x 1

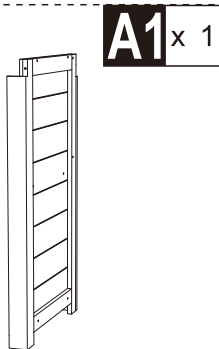

**A1** x 1

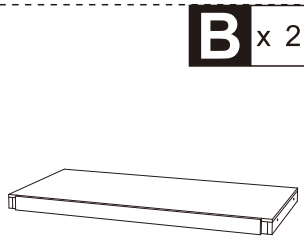

**B** x 2

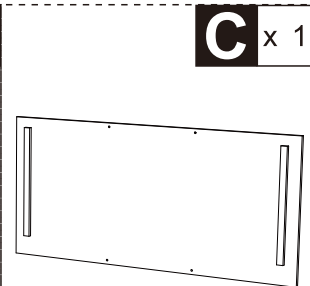

**C** x 1

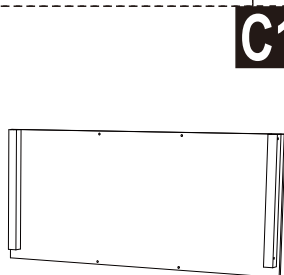

**C1** x 1

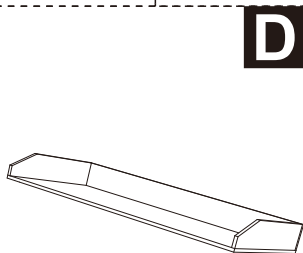

**D** x 1

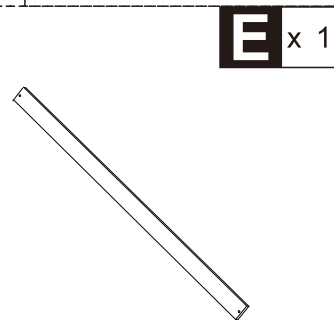

**E** x 1

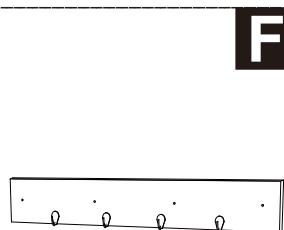

**F** x 1



**G** x 2

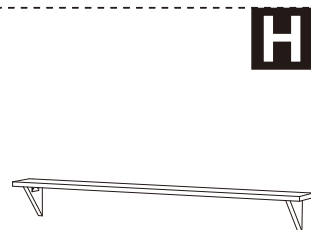

**H** x 1

**HARDWARE**

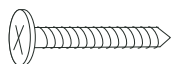

**1** x 24  
M4\*35  
+1(spare)

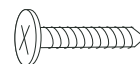

**2** x 8  
M4\*25  
+1(spare)

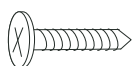

**3** x 8  
M4\*20  
+1(spare)



**4** x 1  
M4

① x 4  
M4\*35

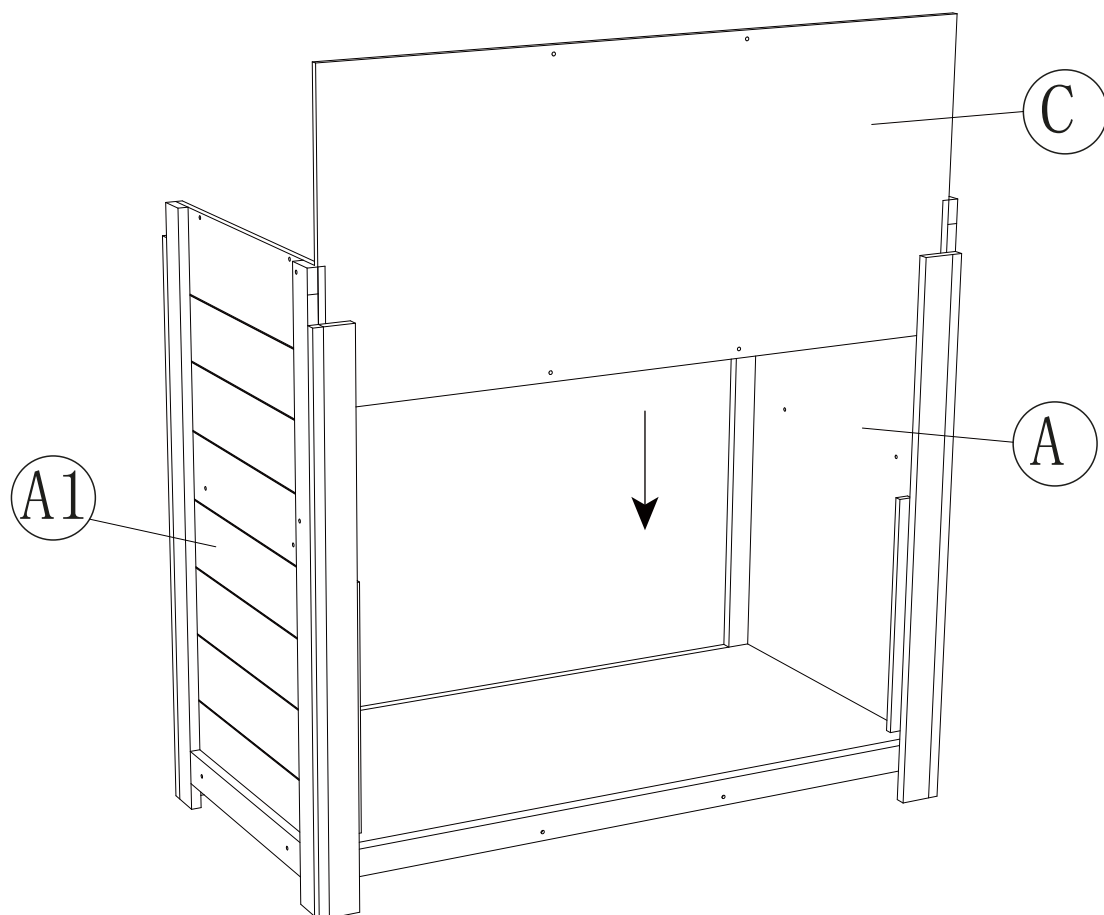
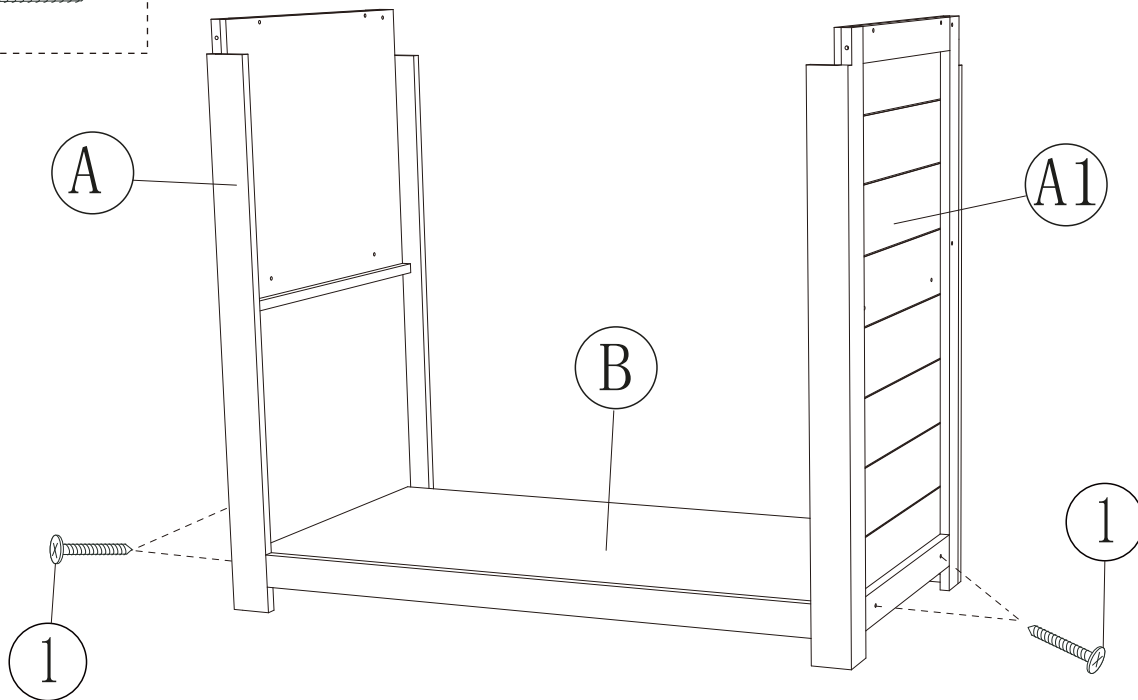
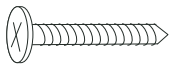

2 x 4  
M4\*25

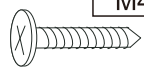

3 x 4  
M4\*20

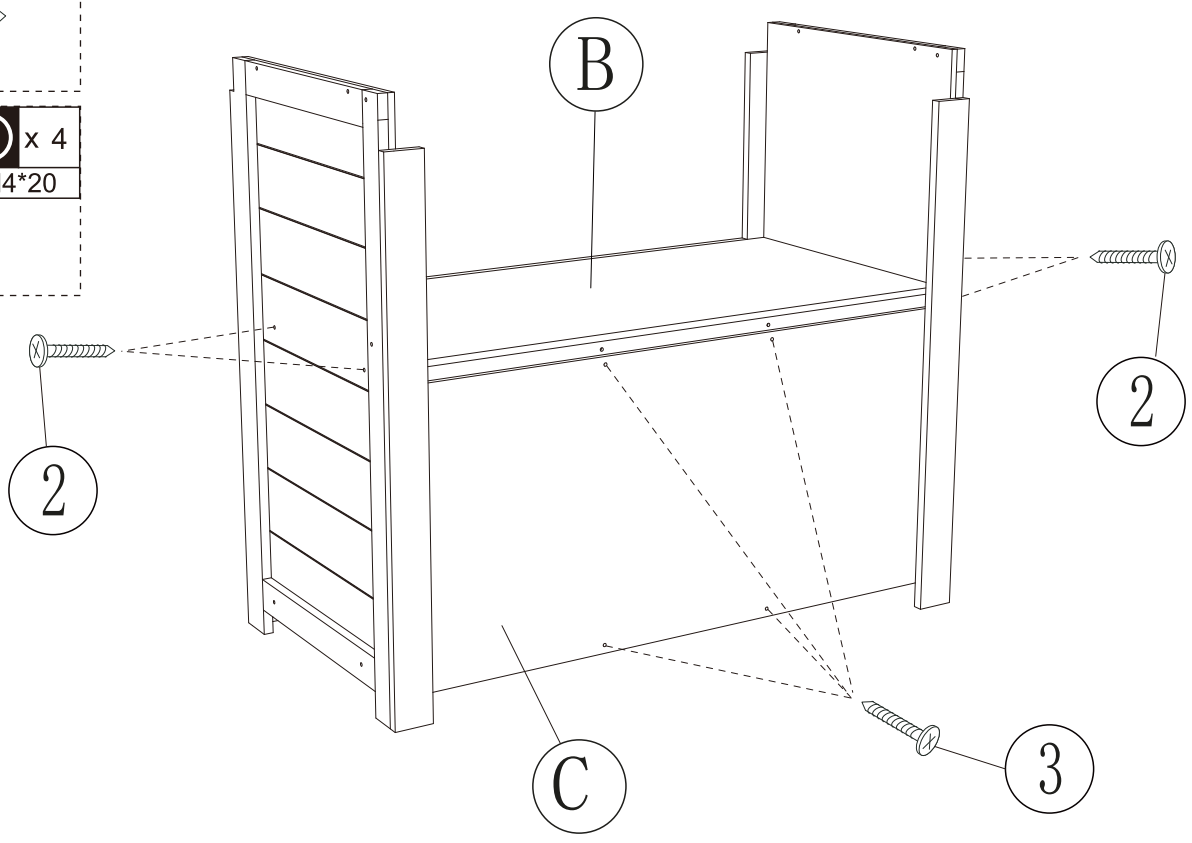
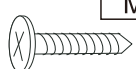

1 x 2  
M4\*35

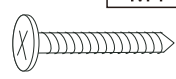

3 x 2  
M4\*20

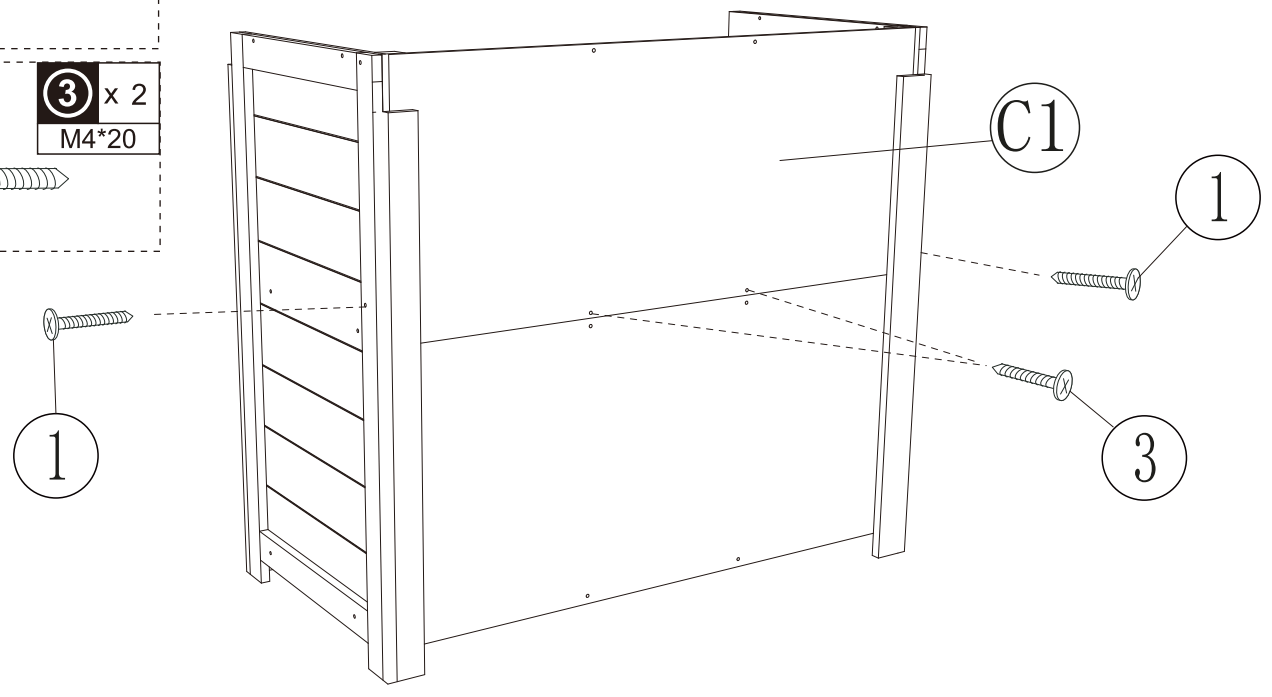
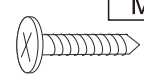

① x 6  
M4\*35

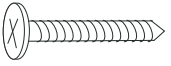

③ x 2  
M4\*20

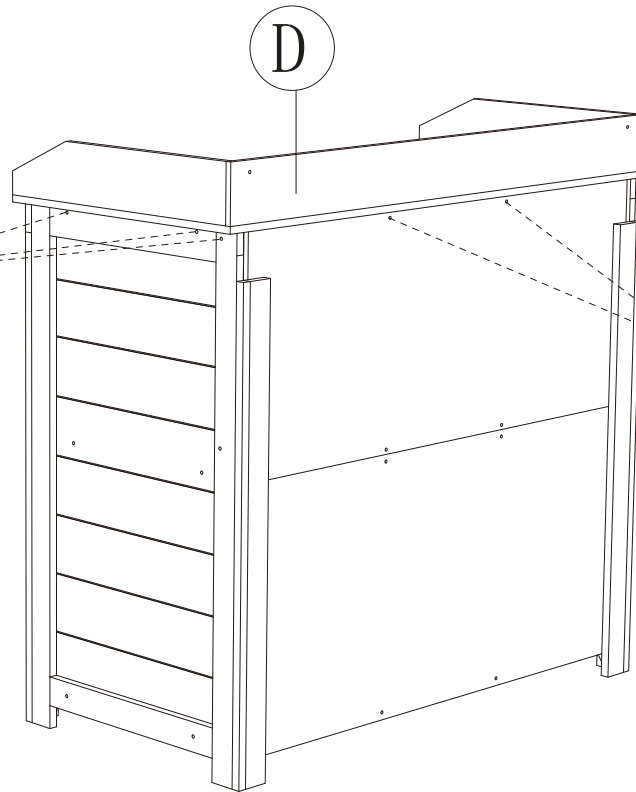
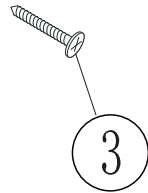
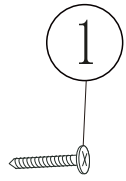
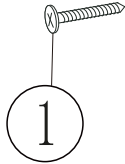
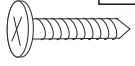

① x 4  
M4\*35

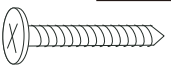

② x 2  
M4\*25

